

The BIMAK company assumes no responsibility for deformation of the profiles resulting from use of a poor quality slab. Maximal leaf weight 75kg.

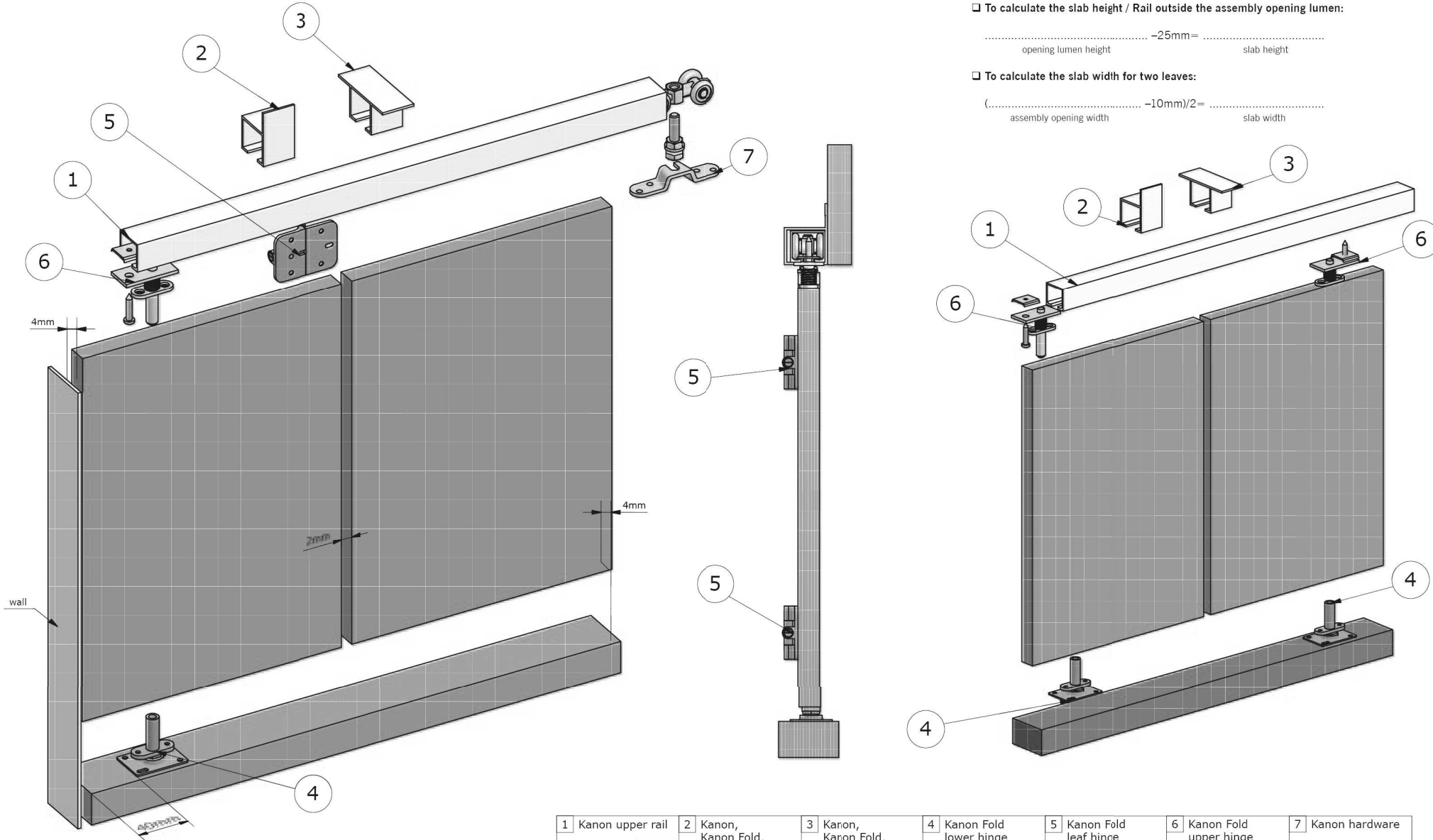

□ To calculate the slab height / Rail in the assembly opening lumen:

$$\dots\dots\dots -55\text{mm} = \dots\dots\dots$$

opening lumen height slab height

□ To calculate the slab height / Rail outside the assembly opening lumen:







$$\dots\dots\dots -25\text{mm} = \dots\dots\dots$$

opening lumen height slab height

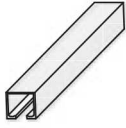
□ To calculate the slab width for two leaves:

$$(\dots\dots\dots -10\text{mm})/2 = \dots\dots\dots$$

assembly opening width slab width

1	2	3	4	5	6	7
Kanon upper rail	Kanon, Kanon Fold, Kanon Glass wall handle	Kanon, Kanon Fold, Kanon Glass ceiling handle	Kanon Fold lower hinge	Kanon Fold leaf hinge	Kanon Fold upper hinge	Kanon hardware
						
TGK	W100	W200	F100-ZD	F100-ZS	F100-ZG	WK-75W